

7310080 NL/NS Sik = 🔊

7320080 = 🔊 ~

Pos. Nr. Pos.no.	Beschreibung Description	Art.-Nr. Art.no.	Preisgruppe Price bracket
1	Gehäuse kpl. Betr. Nr. 309 Body ass. complete Loco no. 309	152142	34
2	Zugfunkantenne Radio antenna	145817	3
3	Stirnlampe Front lamp	143927	5
4	Kran kpl. Crane compl.	152143	11
5	Fenster li. + re. Windows L + R	143929	6
6	TS - Griffe Part set - handles	143931	7
7	Rauchfang + Lüftergitter Chimney + ventilator grills	143932	5
8	Griffe kurz + lang Handles short + long	143933	7
9	Stirnlampe Front lamp	145871	5
10	Blinklicht rot Blinking light red	145813	5
11	LED-Abdeckung LED-Cover	143936	15
12	Lautsprecher Loudspeaker	129524	13
13	Blinddeckel Blind cover	143937	4
14	Führerhausgewicht R+L Driver's cab weight r+l	143938	11
15	TS - Bremshebel Part set - brake lever	143923	6
16	Lampen L+R Lamps l+r	143924	6
17	TS - Lichtleiter+Linsen+Signal Part set - light conductor+lenses+signal light	143917	7
18	TS - Laufbretter Part set - Runway	146817	8
19	TS-Sandkasten Part set-Sandboxes	145808	6
20	Platine PCB	143908	40
21	GF-Schraube M1,6x3 mm GF - screw	143760	4
22	Griff Pufferbohle Buffer beam handle	143930	6
23	TS - Lichtleiter+Linsen Part set - light conductor+lenses	145873	7
24	Hydrauliktank Hydraulic tank	145818	3
25	Dach Kran Roof crane	145814	8
26	Dachaufsatz Roof ass.	145815	7

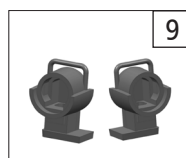
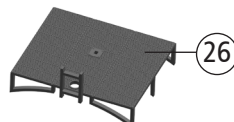
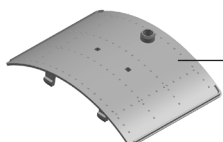
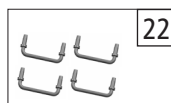
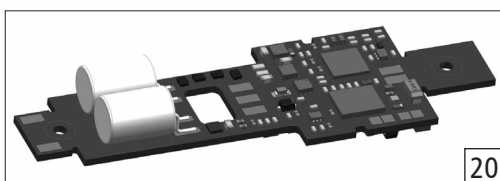
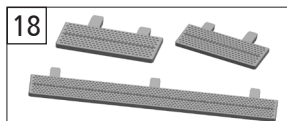
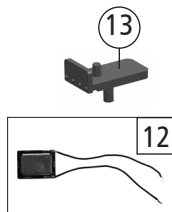
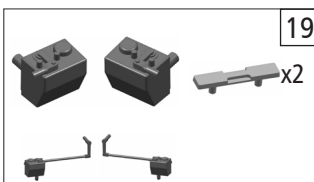
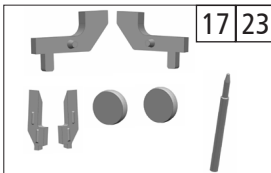
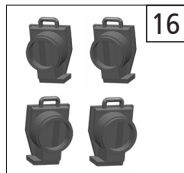
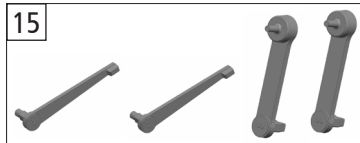
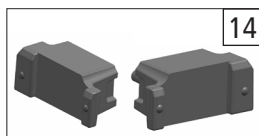
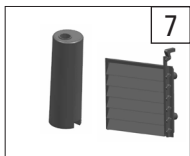
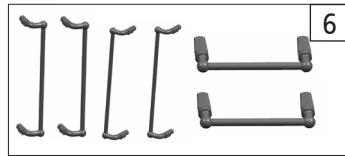
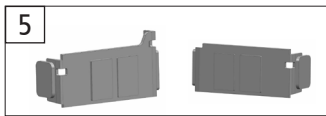
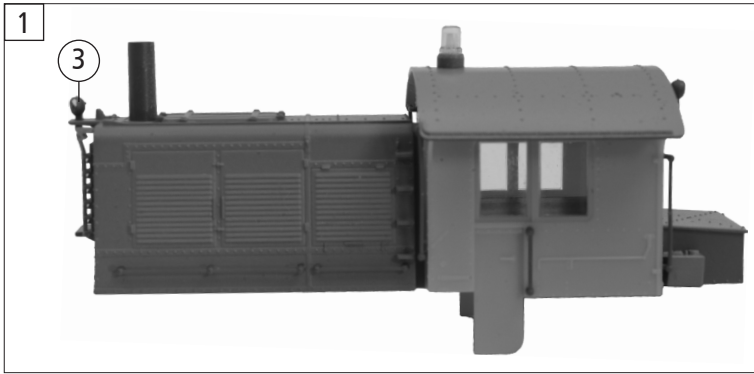

Änderungen in Konstruktion und Ausführung vorbehalten
We reserve the right to change the construction and specification

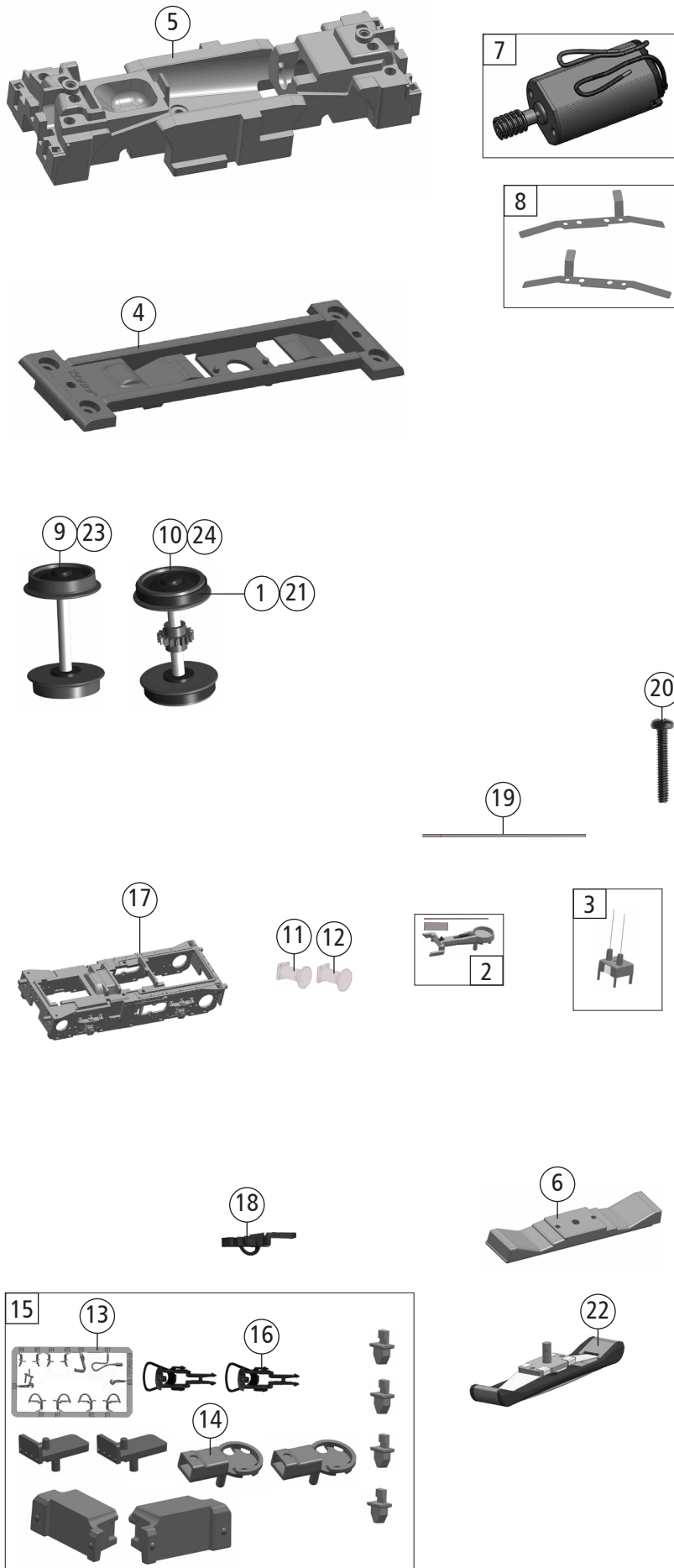

7310080		NL/NS	Sik	=	🔊	
7320080				=	🔊	~
Pos. Nr. Pos.no.	Beschreibung Description	Art.-Nr. Art.no.	Preisgruppe Price bracket			
1	Hafttrings.10Stk.10,3 bis 12,8m Traction tyres	40069	---			
2	TS - Digital Kupplung Part set - digital coupling	143911	11			
3	Spule kpl. Spool complete	143912	13			
4	Lokboden Loco chassis	143913	13			
5	Grundrahmen Base frame	146815	13			
6	Schleifergewicht Slider weight	143915	8			
7	Motor m. Schnecke Motor with wormgear	143770	16			
8	Radkontakt L+R Wheel contact l+r	143919	11			
9	Radsatz o. Zahnrad o. Haftring Wheelset w/o gearwheel w/o tract. tyre	143909	10			
10	Radsatz m. Zahnrad m. 2 Haftringe Wheelset w. gearwheel w. 2 tract. tyres	143910	12			
11	Puffer flach Buffer flat	143921	3			
12	Puffer gewölbt Buffer curved	143922	3			
13	TS - Bremsschläuche + Zughaken Part set of brake tubes & coupling hooks	139832	7			
14	Kupplungskammer Coupling reception	143939	4			
15	Zurüstbeutel Bag of accesories	146822	16			
16	Standardkupplung Standard coupling	89246	6			
17	Blende Bogie	146816	22			
18	Kurzkupplung Short coupling	115550	6			
19	Federdraht Flat spring	145095	4			
20	GF-Schraube M1,6x14 mm GF-Screw	145805	5			
AC - Wechselstrom						
21	Haftreifen Traction tyres	00544007	1			
22	Schleifer Slider	86030	14			
23	Radsatz o. Zahnrad o. Haftring AC Wheelset w/o gearwheel w/o tract. tyre	143946	10			
24	Radsatz m. Zahnrad m. 2 Haftringe AC Wheelset w. gearwheel w. 2 tract. tyres	143947	12			